

SCHWINGMETALL® Puffer

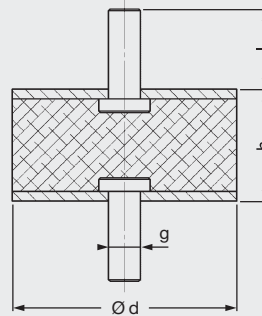
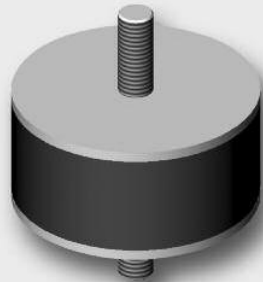

Abmessungen				Federsteifigkeiten			max. Belastungen			Masse Stück [kg]	Elastomer Härte [Shore A]	Form-Nr.	Artikel-Nr.
d [mm]	h [mm]	l [mm]	g	C _x [N/mm]	C _y [N/mm]	C _z [N/mm]	F _x [N]	F _y [N]	F _z [N]				
15	8	10	M4	11	11	92	35	35	90	0,006	40	21682/A	3911403000
15	8	10	M4	19	19	170	40	40	125	0,006	55	21682/A	3911203000
15	8	10	M4	29	29	262	43	43	160	0,006	65	21682/A	3911103000
15	15	13	M4	5	5	32	35	35	90	0,008	40	25326/A	3911404000
15	15	13	M4	9	9	62	40	40	125	0,008	55	25326/A	3911204000
15	15	13	M4	14	14	97	43	43	160	0,008	65	25326/A	3911104000
15	30	16	M4	1	1	12	34	34	90	0,011	40	25259/A	3911405000
15	30	16	M4	3	3	23	36	36	100	0,011	55	25259/A	3911205000
15	30	16	M4	4	4	37	37	37	160	0,011	65	25259/A	3911105000
20	25	19	M6	5	5	27	60	60	150	0,022	40	31658/A	3911406000
20	25	19	M6	9	9	53	65	65	180	0,022	55	31658/A	3911206000
20	25	19	M6	13	13	84	70	70	225	0,022	65	31658/A	3911106000
25	10	18,5	M6	41	41	651	100	100	250	0,019	40	25388/A	3911407000
25	10	18,5	M6	77	77	1125	110	110	400	0,019	55	25388/A	3911207000
25	10	18,5	M6	120	120	1695	120	120	500	0,019	65	25388/A	3911107000
25	15	18,5	M6	22	22	149	100	100	250	0,022	40	20292a/A	3911408000
25	15	18,5	M6	41	41	274	110	110	400	0,022	55	20292a/A	3911208000
25	15	18,5	M6	64	64	423	120	120	420	0,022	65	20292a/A	3911108000
25	20	18,5	M6	13	13	65	100	100	250	0,025	40	20292/A	3911410000
25	20	18,5	M6	24	24	126	110	110	350	0,025	55	20292/A	3911210000
25	20	18,5	M6	37	37	198	120	120	370	0,025	65	20292/A	3911110000
25	30	18,5	M6	7	7	37	100	100	250	0,029	40	21239/A	3911411000
25	30	18,5	M6	13	13	72	110	110	300	0,029	55	21239/A	3911211000
25	30	18,5	M6	20	20	113	120	120	400	0,029	65	21239/A	3911111000
30	20	20,5	M8	20	20	112	150	150	350	0,047	40	25356/A	3911412000
30	20	20,5	M8	36	36	213	160	160	550	0,047	55	25356/A	3911212000
30	20	20,5	M8	56	56	331	170	170	650	0,047	65	25356/A	3911112000
30	30	20,5	M8	10	10	58	150	150	350	0,054	40	31660/A	3911413000
30	30	20,5	M8	17	17	112	160	160	400	0,054	55	31660/A	3911213000
30	30	20,5	M8	26	26	176	170	170	600	0,054	65	31660/A	3911113000
40	30	24,5	M8	19	19	109	250	250	630	0,092	40	20291/A	3911414000
40	30	24,5	M8	35	35	211	260	260	850	0,092	55	20291/A	3911214000
40	30	24,5	M8	54	54	330	270	270	1050	0,092	65	20291/A	3911114000
40	40	24,5	M8	12	12	69	250	250	600	0,104	40	27796/A	3911431000
40	40	24,5	M8	21	21	135	260	260	730	0,104	55	27796/A	3911231000
40	40	24,5	M8	32	32	214	270	270	890	0,104	65	27796/A	3911131000

Puffer Typ A													
Abmessungen				Federsteifigkeiten			max. Belastungen			Masse Stück [kg]	Elastomer Härte [Shore A]	Form-Nr.	Artikel-Nr.
d [mm]	h [mm]	l [mm]	g	C _x [N/mm]	C _y [N/mm]	C _z [N/mm]	F _x [N]	F _y [N]	F _z [N]				
50	20	28	M10	60	60	467	400	400	1000	0,140	40	25332/A	3911417000
50	20	28	M10	110	110	858	420	420	1450	0,140	55	25332/A	3911217000
50	20	28	M10	170	170	1321	440	440	2300	0,140	65	25332/A	3911117000
50	30	34	M10	34	34	177	400	400	950	0,165	40	25333/A	3911418000
50	30	34	M10	62	62	343	420	420	1400	0,165	55	25333/A	3911218000
50	30	34	M10	95	95	539	440	440	2000	0,165	65	25333/A	3911118000
50	45	34	M10	20	20	104	392	392	950	0,200	40	27797/A	3911419000
50	45	34	M10	35	35	204	410	410	1300	0,200	55	27797/A	3911219000
50	45	34	M10	54	54	322	430	430	1800	0,200	65	27797/A	3911119000
70	35	25	M10	69	69	423	750	750	1950	0,340	40	20290a/A	3911441000
70	35	25	M10	127	127	793	790	790	2750	0,340	55	20290a/A	3911241000
70	35	25	M10	198	198	1231	830	830	3750	0,340	65	20290a/A	3911141000
70	45	25	M10	47	47	265	750	750	1900	0,382	40	20290/A	3911420000
70	45	25	M10	86	86	507	790	790	2650	0,382	55	20290/A	3911220000
70	45	25	M10	133	133	793	830	830	3600	0,382	65	20290/A	3911120000
70	60	25	M10	31	31	162	750	750	1900	0,445	40	20290b/A	3911442000
70	60	25	M10	56	56	315	790	790	2600	0,445	55	20290b/A	3911242000
70	60	25	M10	86	86	497	830	830	3500	0,445	65	20290b/A	3911142000
75	40	37	M12	62	62	400	900	900	2200	0,445	40	25327/A	3911421000
75	40	37	M12	112	112	751	1000	1000	3500	0,445	55	25327/A	3911221000
75	40	37	M12	173	173	1166	1050	1050	4500	0,445	65	25327/A	3911121000
75	55	37	M12	39	39	214	900	900	2200	0,518	40	25336/A	3911422000
75	55	37	M12	70	70	412	1000	1000	2950	0,518	55	25336/A	3911222000
75	55	37	M12	108	108	647	1050	1050	4050	0,518	65	25336/A	3911122000
100	40	43	M16	130	130	1087	1500	1500	5200	0,910	40	25334/A	3911424000
100	40	43	M16	241	241	1972	1600	1600	7500	0,910	55	25334/A	3911224000
100	40	43	M16	375	375	3021	1700	1700	10500	0,910	65	25334/A	3911124000
100	55	43	M16	73	73	438	1500	1500	4500	1,080	40	25335/A	3911425000
100	55	43	M16	132	132	838	1600	1600	6200	1,080	55	25335/A	3911225000
100	55	43	M16	204	204	1311	1700	1700	8300	1,080	65	25335/A	3911125000
100	75	43	M16	53	53	279	1500	1500	4000	1,253	40	25328/A	3911446000
100	75	43	M16	96	96	540	1600	1600	5800	1,253	55	25328/A	3911246000
100	75	43	M16	149	149	848	1700	1700	7500	1,253	65	25328/A	3911146000

Belastungsrichtungen

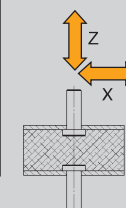

SCHWINGMETALL® Puffer

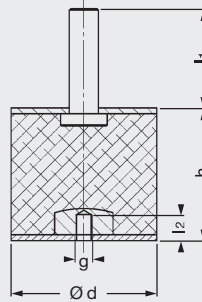

Puffer Typ B														
Abmessungen					Federsteifigkeiten			max. Belastungen			Masse	Elastomer Härte	Form-Nr.	Artikel-Nr.
d [mm]	h [mm]	l1 [mm]	l2 [mm]	g	C _x [N/mm]	C _y [N/mm]	C _z [N/mm]	F _x [N]	F _y [N]	F _z [N]	Stück [kg]	[Shore A]		
15	15	13,0	4,5	M4	7	7	41	35	35	90	0,007	40	25326/B	3912404000
15	15	13,0	4,5	M4	12	12	77	40	40	125	0,007	55	25326/B	3912204000
15	15	13,0	4,5	M4	19	19	120	43	43	160	0,007	65	25326/B	3912104000
15	30	16,0	4,5	M4	1	1	13	34	34	90	0,010	40	25259/B	3912405000
15	30	16,0	4,5	M4	3	3	26	36	36	125	0,010	55	25259/B	3912205000
15	30	16,0	4,5	M4	4	4	41	37	37	160	0,010	65	25259/B	3912105000
20	25	19,0	6,0	M6	7	7	39	60	60	150	0,021	40	31658/B	3912406000
20	25	19,0	6,0	M6	12	12	73	65	65	180	0,021	55	31658/B	3912206000
20	25	19,0	6,0	M6	19	19	114	70	70	225	0,021	65	31658/B	3912106000
25	15	18,5	6,0	M6	42	42	250	100	100	250	0,023	40	20292a/B	3912408000
25	15	18,5	6,0	M6	80	80	445	110	110	400	0,023	55	20292a/B	3912208000
25	15	18,5	6,0	M6	125	125	676	120	120	500	0,023	65	20292a/B	3912108000
25	20	18,5	6,0	M6	18	18	74	100	100	250	0,025	40	20292/B	3912410000
25	20	18,5	6,0	M6	34	34	141	110	110	350	0,025	55	20292/B	3912210000
25	20	18,5	6,0	M6	53	53	220	120	120	450	0,025	65	20292/B	3912110000
25	30	18,5	6,0	M6	9	9	37	100	100	250	0,031	40	21239/B	3912411000
25	30	18,5	6,0	M6	16	16	72	110	110	300	0,031	55	21239/B	3912211000
25	30	18,5	6,0	M6	24	24	113	120	120	400	0,031	65	21239/B	3912111000
30	20	20,5	7,0	M8	24	24	112	150	150	350	0,045	40	25356/B	3912412000
30	20	20,5	7,0	M8	43	43	212	160	160	500	0,045	55	25356/B	3912212000
30	20	20,5	7,0	M8	67	67	330	170	170	600	0,045	65	25356/B	3912112000
30	30	30,0	7,0	M8	11	11	66	150	150	350	0,052	40	31660/B	3912413000
30	30	30,0	7,0	M8	20	20	126	160	160	420	0,052	55	31660/B	3912213000
30	30	30,0	7,0	M8	31	31	196	170	170	600	0,052	65	31660/B	3912113000
40	30	24,5	7,0	M8	25	25	140	250	250	630	0,084	40	20291/B	3912414000
40	30	24,5	7,0	M8	46	46	262	260	260	850	0,084	55	20291/B	3912214000
40	30	24,5	7,0	M8	71	71	406	270	270	1050	0,084	65	20291/B	3912114000
40	40	24,5	7,0	M8	13	13	79	250	250	600	0,096	40	27796/B	3912426000
40	40	24,5	7,0	M8	23	23	151	260	260	730	0,096	55	27796/B	3912226000
40	40	24,5	7,0	M8	36	36	238	270	270	890	0,096	65	27796/B	3912126000

Puffer Typ B

Abmessungen					Federsteifigkeiten			max. Belastungen			Masse	Elas- tomer Härte	Form-Nr.	Artikel-Nr.
d [mm]	h [mm]	l ₁ [mm]	l ₂ [mm]	g	C _x [N/mm]	C _y [N/mm]	C _z [N/mm]	F _x [N]	F _y [N]	F _z [N]	Stück [kg]	[Shore A]		
50	20	28,0	8,8	M10	71	71	938	400	400	1000	0,122	40	25332/B	3912417000
50	20	28,0	8,8	M10	132	132	1645	420	420	1450	0,122	55	25332/B	3912217000
50	20	28,0	8,8	M10	206	206	2486	440	440	2300	0,122	65	25332/B	3912117000
50	30	34,0	8,8	M10	40	40	201	400	400	950	0,150	40	25333/B	3912418000
50	30	34,0	8,8	M10	74	74	384	420	420	1400	0,150	55	25333/B	3912218000
50	30	34,0	8,8	M10	115	115	600	440	440	1800	0,150	65	25333/B	3912118000
50	45	34,0	8,8	M10	20	20	104	390	390	950	0,180	40	27797/B	3912419000
50	45	34,0	8,8	M10	35	35	204	410	410	1300	0,180	55	27797/B	3912219000
50	45	34,0	8,8	M10	54	54	322	430	430	1800	0,180	65	27797/B	3912119000
70	45	25,0	8,8	M10	47	47	265	750	750	1900	0,347	40	20290/B	3912420000
70	45	25,0	8,8	M10	86	86	507	790	790	2650	0,347	55	20290/B	3912220000
70	45	25,0	8,8	M10	133	133	793	830	830	3600	0,347	65	20290/B	3912120000
75	40	37,0	11,5	M12	62	62	400	900	900	2200	0,419	40	25327/B	3912421000
75	40	37,0	11,5	M12	112	112	751	1000	1000	3500	0,419	55	25327/B	3912221000
75	40	37,0	11,5	M12	173	173	1166	1050	1050	4500	0,419	65	25327/B	3912121000
75	55	37,0	11,5	M12	46	46	242	900	900	2200	0,487	40	25336/B	3912422000
75	55	37,0	11,5	M12	84	84	461	1000	1000	2950	0,487	55	25336/B	3912222000
75	55	37,0	11,5	M12	130	130	720	1050	1050	4050	0,487	65	25336/B	3912122000
100	40	43,0	17,0	M16	156	156	1359	1500	1500	5200	0,889	40	25334/B	3912424000
100	40	43,0	17,0	M16	290	290	2427	1600	1600	7500	0,889	55	25334/B	3912224000
100	40	43,0	17,0	M16	453	453	3695	1650	1650	10500	0,889	65	25334/B	3912124000
100	55	43,0	17,0	M16	86	86	496	1500	1500	4500	1,026	40	25335/B	3912425000
100	55	43,0	17,0	M16	158	158	937	1600	1600	6200	1,026	55	25335/B	3912225000
100	55	43,0	17,0	M16	246	246	1458	1700	1700	8300	1,026	65	25335/B	3912125000
100	75	43,0	17,0	M16	53	53	279	1500	1500	4000	1,200	40	25328/B	3912446000
100	75	43,0	17,0	M16	96	96	540	1600	1600	5800	1,200	55	25328/B	3912246000
100	75	43,0	17,0	M16	149	149	848	1700	1700	7500	1,200	65	25328/B	3912146000

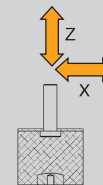
Belastungsrichtungen

SCHWINGMETALL® Puffer

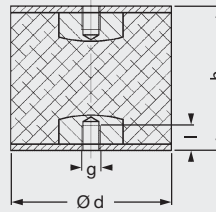

Puffer Typ C													
Abmessungen				Federsteifigkeiten			max. Belastungen			Masse Stück [kg]	Elastomer Härte [Shore A]	Form-Nr.	Artikel-Nr.
d [mm]	h [mm]	l [mm]	g	C _x [N/mm]	C _y [N/mm]	C _z [N/mm]	F _x [N]	F _y [N]	F _z [N]				
13	26	5,0	M4	2	2	13	25	25	65	0,009	40	21887/C	3913402000
13	26	5,0	M4	3	3	25	27	27	80	0,009	55	21887/C	3913202000
13	26	5,0	M4	4	4	40	29	29	110	0,009	65	21887/C	3913102000
15	15	4,5	M4	13	13	68	35	35	90	0,007	40	25326/C	3913404000
15	15	4,5	M4	24	24	125	40	40	125	0,007	55	25326/C	3913204000
15	15	4,5	M4	37	37	190	43	43	160	0,007	65	25326/C	3913104000
20	25	6,0	M6	8	8	39	60	60	150	0,020	40	31658/C	3913406000
20	25	6,0	M6	14	14	73	65	65	180	0,020	55	31658/C	3913206000
20	25	6,0	M6	22	22	114	70	70	225	0,020	65	31658/C	3913106000
30	20	7,0	M8	30	30	230	150	150	400	0,042	40	25356/C	3913412000
30	20	7,0	M8	56	56	410	160	160	500	0,042	55	25356/C	3913212000
30	20	7,0	M8	87	87	626	170	170	650	0,042	65	25356/C	3913112000
30	30	7,0	M8	13	13	74	150	150	350	0,051	40	31660/C	3913413000
30	30	7,0	M8	24	24	139	160	160	420	0,051	55	31660/C	3913213000
30	30	7,0	M8	37	37	217	170	170	600	0,051	65	31660/C	3913113000
40	30	7,0	M8	29	29	189	250	250	630	0,072	40	20291/C	3913414000
40	30	7,0	M8	54	54	346	260	260	850	0,072	55	20291/C	3913214000
40	30	7,0	M8	83	83	533	270	270	1050	0,072	65	20291/C	3913114000
40	40	7,0	M8	14	14	89	250	250	600	0,090	40	27796/C	3913415000
40	40	7,0	M8	25	25	168	260	260	730	0,090	55	27796/C	3913215000
40	40	7,0	M8	39	39	263	270	270	890	0,090	65	27796/C	3913115000
50	45	8,8	M10	23	23	119	390	390	950	0,169	40	27797/C	3913419000
50	45	8,8	M10	42	42	228	410	410	1300	0,169	55	27797/C	3913219000
50	45	8,8	M10	65	65	358	430	430	1800	0,169	65	27797/C	3913119000
70	45	8,8	M10	71	71	529	750	750	1900	0,317	40	20290/C	3913420000
70	45	8,8	M10	132	132	953	790	790	2650	0,317	55	20290/C	3913220000
70	45	8,8	M10	207	207	1457	830	830	3600	0,317	65	20290/C	3913120000
75	55	11,5	M12	55	55	272	900	900	2200	0,455	40	25336/C	3913422000
75	55	11,5	M12	101	101	512	1000	1000	2950	0,455	55	25336/C	3913222000
75	55	11,5	M12	157	157	796	1050	1050	4050	0,455	65	25336/C	3913122000

Puffer Typ C													
Abmessungen				Federsteifigkeiten			max. Belastungen			Masse Stück [kg]	Elastomer Härte [Shore A]	Form-Nr.	Artikel-Nr.
d [mm]	h [mm]	l [mm]	g	C _x [N/mm]	C _y [N/mm]	C _z [N/mm]	F _x [N]	F _y [N]	F _z [N]				
100	55	17,0	M16	103	103	561	1700	1700	4500	0,990	40	25335/C	3913425000
100	55	17,0	M16	191	191	1045	1900	1900	6200	0,990	55	25335/C	3913225000
100	55	17,0	M16	297	297	1619	2100	2100	8300	0,990	65	25335/C	3913125000
100	75	17,0	M16	53	53	279	1500	1500	4000	1,165	40	25328/C	3913426000
100	75	17,0	M16	96	96	540	1600	1600	5800	1,165	55	25328/C	3913226000
100	75	17,0	M16	149	149	848	1700	1700	7500	1,165	65	25328/C	3913126000
150	55	20,0	1)	216	216	1948	3500	3500	11000	2,500	40	31475/C	3913427000
150	55	20,0	1)	398	398	3511	3750	3750	16000	2,500	55	31475/C	3913227000
150	55	20,0	1)	621	621	5363	4000	4000	21000	2,500	65	31475/C	3913127000
150	75	20,0	1)	139	139	858	3500	3500	9500	2,950	40	25303/C	3913428000
150	75	20,0	1)	254	254	1613	3750	3750	14500	2,950	55	25303/C	3913228000
150	75	20,0	1)	395	395	2507	4000	4000	19000	2,950	65	25303/C	3913128000
200	100	20,0	1)	160	160	929	6000	6000	17500	5,920	40	25329/C	3913429000
200	100	20,0	1)	291	291	1802	6400	6400	25000	5,920	55	25329/C	3913229000
200	100	20,0	1)	451	451	2834	6800	6800	33500	5,920	65	25329/C	3913129000

1) geeignet für Gewinde bis M20; Butzendurchmesser 40 mm

Belastungsrichtungen

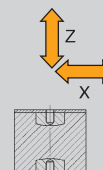

SCHWINGMETALL® Puffer

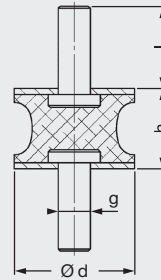

Puffer Typ AK

Abmessungen				Federsteifigkeiten			max. Belastungen			Masse Stück [kg]	Elastomer Härte [Shore A]	Form-Nr.	Artikel-Nr.
d [mm]	h [mm]	l [mm]	g	C _x [N/mm]	C _y [N/mm]	C _z [N/mm]	F _x [N]	F _y [N]	F _z [N]				
20	15	19,0	M6	11	11	48	350	350	290	0,017	40	58302	3916408000
20	15	19,0	M6	19	19	99	50	50	320	0,017	55	58302	3916208000
20	15	19,0	M6	30	30	154	60	60	420	0,017	65	58302	3916108000
30	20	20,5	M8	13	13	92	60	60	580	0,042	40	58236	3916416000
30	20	20,5	M8	23	23	180	90	90	720	0,042	55	58236	3916216000
30	20	20,5	M8	36	36	275	105	105	900	0,042	65	58236	3916116000
50	30	34,0	M10	18	18	134	120	120	1450	0,146	40	58237	3916424000
50	30	34,0	M10	32	32	272	250	250	1800	0,146	55	58237	3916224000
50	30	34,0	M10	49	49	406	270	270	2200	0,146	65	58237	3916124000
75	40	37,0	M12	33	33	295	350	350	3900	0,386	40	58238	3916430000
75	40	37,0	M12	59	59	530	600	600	4500	0,386	55	58238	3916230000
75	40	37,0	M12	91	91	834	650	650	5000	0,386	65	58238	3916130000

Belastungsrichtungen

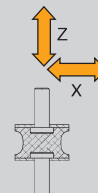

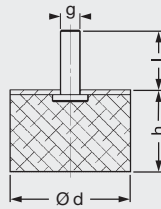
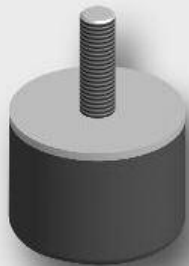

Puffer Typ D

Abmessungen				Federsteifigkeiten			max. Belastung	Masse	Elastomer Härte	Form-Nr.	Artikel-Nr.
d [mm]	h [mm]	l [mm]	g	C _x [N/mm]	C _y [N/mm]	C _z [N/mm]	F _z [N]	Stück [kg]	[Shore A]		
15	13	13,0	M4	10	10	61	110	0,005	55	25326/D	3917204000
15	28	16,0	M4	2	2	23	90	0,008	55	25259/D	3917205000
20	23	19,0	M6	9	9	53	150	0,015	55	31658/D	3917206000
25	8	18,5	M6	79	79	1038	400	0,011	55	25388/D	3917207000
25	13	18,0	M6	43	43	281	325	0,014	55	20292a/D	3917208000
25	18	18,0	M6	25	25	113	250	0,017	55	20292/D	3917210000
25	28	18,5	M6	13	13	69	250	0,022	55	21239/D	3917211000
30	28	20,5	M8	17	17	112	350	0,037	55	31660/D	3917213000
40	28	28,0	M8	37	37	209	650	0,064	55	20291/D	3917214000
40	38	24,5	M8	22	22	134	600	0,077	55	27796/D	3917231000
50	17	28,0	M10	114	114	844	1400	0,084	55	25332/D	3917217000
50	28	34,0	M10	64	64	339	1200	0,109	55	25333/D	3917218000
50	42	34,0	M10	36	36	201	1000	0,140	55	27797/D	3917219000
70	42	25,0	M10	81	81	449	2000	0,278	55	20290/D	3917220000
75	36	37,0	M12	114	114	742	2500	0,300	55	25327/D	3917221000
75	51	37,0	M12	72	72	407	2300	0,380	55	25336/D	3917222000
100	36	43,0	M16	254	254	1956	5500	0,584	55	25334/D	3917224000
100	50	43,0	M16	136	136	825	4400	0,720	55	25335/D	3917225000

Belastungsrichtungen

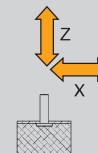

SCHWINGMETALL® Puffer

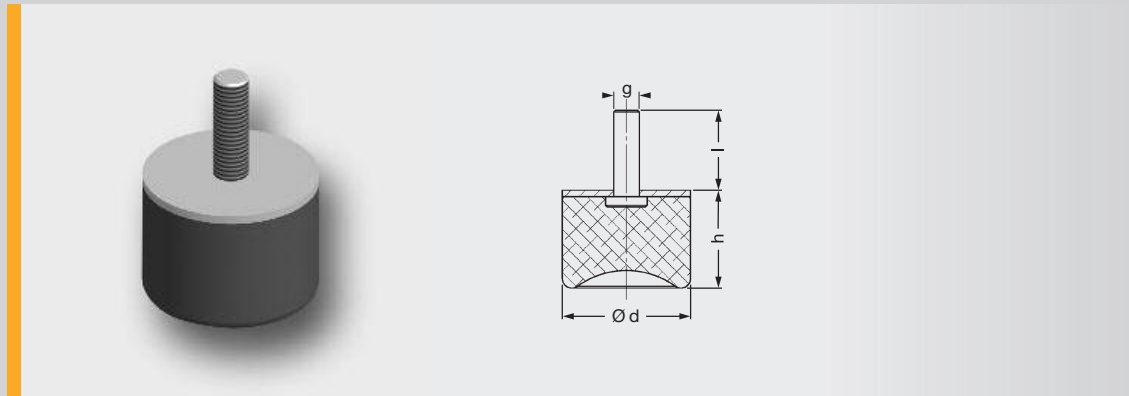

Puffer Typ S											
Abmessungen				Federsteifigkeiten			max. Belastung	Masse	Elastomer Härte	Form-Nr.	Artikel-Nr.
d [mm]	h [mm]	l [mm]	g	C _x [N/mm]	C _y [N/mm]	C _z [N/mm]	F _z [N]	Stück [kg]	[Shore A]		
15	14,0	13,0	M4	8	8	47	100	0,005	55	25326/S	3919204000
20	23,5	23,5	M6	10	10	63	150	0,015	55	31658/S	3919206000
25	18,5	18,5	M6	21	21	95	250	0,017	55	20292/S	3919210000
30	28,5	20,5	M8	13	13	81	350	0,037	55	31660/S	3919213000
40	28,5	24,5	M8	25	25	131	600	0,061	55	20291/S	3919214000
50	28,0	34,0	M10	43	43	208	1000	0,106	55	25333/S	3919218000
70	43,0	25,0	M10	57	57	295	1900	0,264	55	20290/S	3919220000
75	37,0	43,0	M12	64	64	366	2200	0,292	55	25327/S	3919221000
100	50,0	43,0	M16	93	93	513	4100	0,690	55	25335/S	3919225000

Belastungsrichtungen

