

SCHWINGMETALL® Schräglager

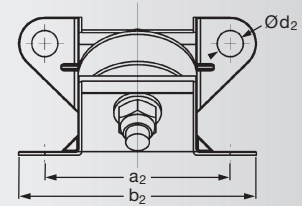
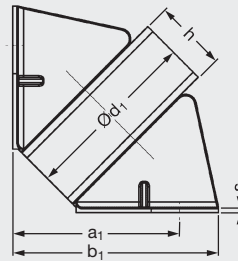

Kombielemente mit Puffer L

Abmessungen

a1 [mm]	a2 [mm]	b1 [mm]	b2 [mm]	d1 [mm]	d2 [mm]	h [mm]	s [mm]
47	78	58	100	50	11	20	1,5
47	78	58	100	50	11	20	1,5
47	78	58	100	50	11	20	1,5
54	78	65	100	50	11	30	1,5
54	78	65	100	50	11	30	1,5
54	78	65	100	50	11	30	1,5
64	78	75	100	50	11	45	1,5
64	78	75	100	50	11	45	1,5
64	78	75	100	50	11	45	1,5
79	100	91	124	70	11	35	2,5
79	100	91	124	70	11	35	2,5
79	100	91	124	70	11	35	2,5
86	100	98	124	70	11	45	2,5
86	100	98	124	70	11	45	2,5
86	100	98	124	70	11	45	2,5
96	100	108	124	70	11	60	2,5
96	100	108	124	70	11	60	2,5
96	100	108	124	70	11	60	2,5
102	140	117	170	100	11	40	3,5
102	140	117	170	100	11	40	3,5
102	140	117	170	100	11	40	3,5
112	140	127	170	100	11	55	3,5
112	140	127	170	100	11	55	3,5
112	140	127	170	100	11	55	3,5
126	140	141	170	100	11	75	3,5
126	140	141	170	100	11	75	3,5
126	140	141	170	100	11	75	3,5

Federsteifigkeiten			max. Belastungen			Masse Stück [kg]	Elastomer Härte [Shore A]	Form-Nr.	Artikel-Nr.
C _x [N/mm]	C _y [N/mm]	C _z [N/mm]	F _x [N]	F _y [N]	F _z [N]				
60	266	266	400	1000	1000	0,268	40	25332/A	■
110	481	481	420	1250	1250	0,268	55	25332/A	■
170	740	740	440	1500	1500	0,268	65	25332/A	■
34	120	120	400	1000	1000	0,293	40	25333/A	■
62	218	218	420	1200	1200	0,293	55	25333/A	■
95	335	335	440	1400	1400	0,293	65	25333/A	■
20	67	67	392	1000	1000	0,328	40	27797/A	■
35	122	122	410	1200	1200	0,328	55	27797/A	■
54	188	188	430	1400	1400	0,328	65	27797/A	■
69	244	244	750	1850	1850	0,712	40	20290a/A	■
127	442	442	790	2200	2200	0,712	55	20290a/A	■
198	680	680	830	2550	2550	0,712	65	20290a/A	■
47	155	155	750	1850	1850	0,754	40	20290/A	■
86	281	281	790	2150	2150	0,754	55	20290/A	■
133	433	433	830	2350	2350	0,754	65	20290/A	■
31	98	98	750	1850	1850	0,817	40	20290b/A	■
56	177	177	790	2150	2150	0,817	55	20290b/A	■
86	272	272	830	2350	2350	0,817	65	20290b/A	■
130	577	577	1500	3900	3900	1,958	40	25334/A	■
241	1044	1044	1600	4500	4500	1,958	55	25334/A	■
375	1606	1606	1700	5000	5000	1,958	65	25334/A	■
73	265	265	1500	3900	3900	2,128	40	25335/A	■
132	480	480	1600	4300	4300	2,128	55	25335/A	■
204	738	738	1700	4800	4800	2,128	65	25335/A	■
53	179	179	1500	3900	3900	2,301	40	25328/A	■
96	324	324	1600	4100	4100	2,301	55	25328/A	■
149	498	498	1700	4300	4300	2,301	65	25328/A	■

■ Anfertigungsware

Belastungsrichtungen

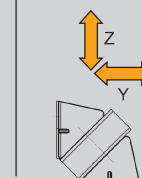

SCHWINGMETALL® Schräglager

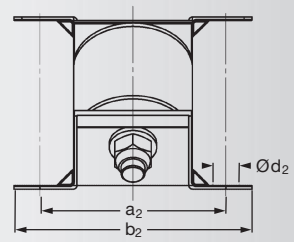
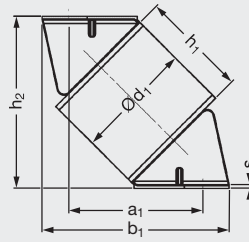

Kombielemente mit Puffer Z

Abmessungen								
a1 [mm]	a2 [mm]	b1 [mm]	b2 [mm]	d1 [mm]	d2 [mm]	h1 [mm]	h2 [mm]	s [mm]
39	78	61	100	50	11	20	55	1,5
39	78	61	100	50	11	20	55	1,5
39	78	61	100	50	11	20	55	1,5
46	78	68	100	50	11	30	62	1,5
46	78	68	100	50	11	30	62	1,5
46	78	68	100	50	11	30	62	1,5
57	78	79	100	50	11	45	72	1,5
57	78	79	100	50	11	45	72	1,5
57	78	79	100	50	11	45	72	1,5
75	100	99	124	70	11	35	83	2,5
75	100	99	124	70	11	35	83	2,5
75	100	99	124	70	11	35	83	2,5
82	100	106	124	70	11	45	90	2,5
82	100	106	124	70	11	45	90	2,5
82	100	106	124	70	11	45	90	2,5
92	100	116	124	70	11	60	100	2,5
92	100	116	124	70	11	60	100	2,5
92	100	116	124	70	11	60	100	2,5
93	140	123	170	100	11	40	111	3,5
93	140	123	170	100	11	40	111	3,5
93	140	123	170	100	11	40	111	3,5
103	140	133	170	100	11	55	122	3,5
103	140	133	170	100	11	55	122	3,5
103	140	133	170	100	11	55	122	3,5
117	140	147	170	100	11	75	136	3,5
117	140	147	170	100	11	75	136	3,5
117	140	147	170	100	11	75	136	3,5

Federsteifigkeiten			max. Belastungen			Masse Stück [kg]	Elastomer Härte [Shore A]	Form-Nr.	Artikel-Nr.
C _x [N/mm]	C _y [N/mm]	C _z [N/mm]	F _x [N]	F _y [N]	F _z [N]				
60	266	266	400	1000	1000	0,268	40	25332/A	■
110	481	481	420	1250	1250	0,268	55	25332/A	■
170	740	740	440	1500	1500	0,268	65	25332/A	■
34	120	120	400	1000	1000	0,293	40	25333/A	3911618000
62	218	218	420	1200	1200	0,293	55	25333/A	3911518000
95	335	335	440	1400	1400	0,293	65	25333/A	■
20	67	67	392	1000	1000	0,328	40	27797/A	3911619000
35	122	122	410	1200	1200	0,328	55	27797/A	3911519000
54	188	188	430	1400	1400	0,328	65	27797/A	■
69	244	244	750	1850	1850	0,712	40	20290a/A	■
127	442	442	790	2200	2200	0,712	55	20290a/A	■
198	680	680	830	2550	2550	0,712	65	20290a/A	■
47	155	155	750	1850	1850	0,754	40	20290/A	3911620000
86	281	281	790	2150	2150	0,754	55	20290/A	3911520000
133	433	433	830	2350	2350	0,754	65	20290/A	■
31	98	98	750	1850	1850	0,817	40	20290b/A	3911642000
56	177	177	790	2150	2150	0,817	55	20290b/A	3911542000
86	272	272	830	2350	2350	0,817	65	20290b/A	■
130	577	577	1500	3900	3900	1,958	40	25334/A	■
241	1044	1044	1600	4500	4500	1,958	55	25334/A	■
375	1606	1606	1700	5000	5000	1,958	65	25334/A	■
73	265	265	1500	3900	3900	2,128	40	25335/A	3911625000
132	480	480	1600	4300	4300	2,128	55	25335/A	3911525000
204	738	738	1700	4800	4800	2,128	65	25335/A	■
53	179	179	1500	3900	3900	2,301	40	25328/A	3911646000
96	324	324	1600	4100	4100	2,301	55	25328/A	3911546000
149	498	498	1700	4300	4300	2,301	65	25328/A	■

■ Anfertigungsware

Belastungsrichtungen

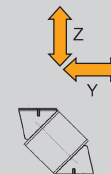

SCHWINGMETALL® Schräglager

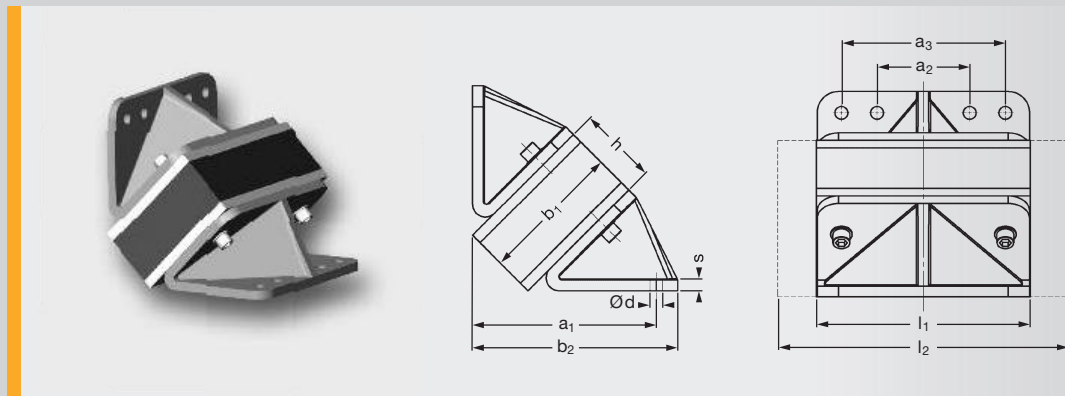

Kombielemente mit Schiene L									
Abmessungen									
a1 [mm]	a2 [mm]	a3 [mm]	b1 [mm]	b2 [mm]	d [mm]	h [mm]	l1 [mm]	l2 [mm]	s [mm]
202	—	150	150	227	4 x 18	80	225	—	15
202	—	150	150	227	4 x 18	80	—	338	15
136	—	110	100	152	4 x 14	60	150	—	10
136	—	110	100	152	4 x 14	60	—	225	10
216	—	150	150	241	4 x 18	100	225	—	15
216	—	150	150	241	4 x 18	100	—	338	15
187	—	150	150	212	4 x 18	60	225	—	15
187	—	150	150	212	4 x 18	60	—	338	15
158	—	110	100	174	4 x 14	90	150	—	10
158	—	110	100	174	4 x 14	90	—	225	10
147	—	110	100	163	4 x 14	75	150	—	10
147	—	110	100	163	4 x 14	75	—	225	10
258	130	230	200	288	8 x 18	110	300	—	15
258	130	230	200	288	8 x 18	110	—	450	15
244	130	230	200	274	8 x 18	90	300	—	15
244	130	230	200	274	8 x 18	90	—	450	15
233	130	230	200	260	8 x 18	70	300	—	15
233	130	230	200	260	8 x 18	70	—	450	15

l1 kurze Ausführung l2 lange Ausführung

Federsteifigkeiten			max. Belastungen			Masse Stück [kg]	Elastomer Härte [Shore A]	Form-Nr.	Artikel-Nr.
C _x [N/mm]	C _y [N/mm]	C _z [N/mm]	F _x [N]	F _y [N]	F _z [N]				
640	3616	3616	6700	20000	20000	20,99	55	21055	■
960	5423	5423	10050	30000	30000	25,92	55	21055	■
480	2931	2931	3400	7500	7500	7,21	55	25079	■
720	4397	4397	5100	11250	11250	9,18	55	25079	■
437	1796	1796	6640	17000	17000	21,73	55	58394	■
656	2694	2694	6640	17000	17000	27,02	55	58394	■
768	9303	9303	6758	22000	22000	20,25	55	21055a	■
1152	13954	13954	10137	33000	33000	24,81	55	21055a	■
183	758	758	3000	7500	7500	7,70	55	24472c	■
275	1137	1137	4500	11250	11250	9,92	55	24472c	■
275	1191	1191	3400	7500	7500	7,46	55	24472d	■
413	1786	1786	5100	11250	11250	9,55	55	24472d	■
735	2917	2917	12100	30000	30000	41,40	55	38417a	■
1103	4376	4376	12100	30000	30000	51,80	55	38417a	■
981	4905	4905	12194	30000	30000	40,10	55	38417b	■
1472	7358	7358	18291	45000	45000	49,80	55	38417b	■
1468	11190	11190	11965	32500	32500	38,70	55	38417c	■
2202	16785	16785	17948	48750	48750	47,80	55	38417c	■

■ Anfertigungsware

Belastungsrichtungen

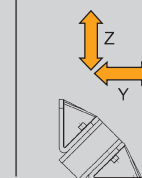

SCHWINGMETALL® Schräglager

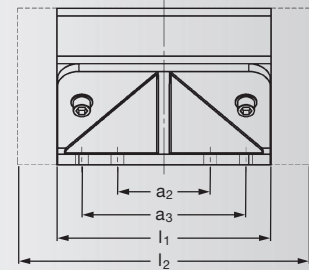
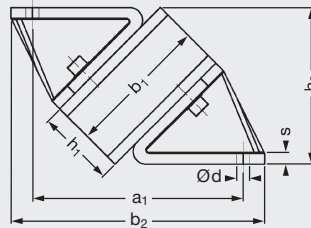
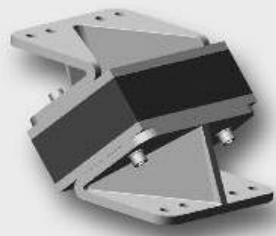

Kombielemente mit Schiene Z

Abmessungen

a1 [mm]	a2 [mm]	a3 [mm]	b1 [mm]	b2 [mm]	d [mm]	h1 [mm]	h2 [mm]	l1 [mm]	l2 [mm]	s [mm]
241	—	150	150	291	4 x 18	80	163	225	—	15
241	—	150	150	291	4 x 18	80	163	—	338	15
160	—	110	100	192	4 x 14	60	113	150	—	10
160	—	110	100	192	4 x 14	60	113	—	225	10
255	—	150	150	305	4 x 18	100	177	225	—	15
255	—	150	150	305	4 x 18	100	177	—	338	15
226	—	150	150	276	4 x 18	60	149	225	—	15
226	—	150	150	276	4 x 18	60	149	—	338	15
181	—	110	100	213	4 x 14	90	134	150	—	10
181	—	110	100	213	4 x 14	90	134	—	225	10
170	—	110	100	202	4 x 14	75	124	150	—	10
170	—	110	100	202	4 x 14	75	124	—	225	10
296	130	230	200	356	8 x 18	110	219	300	—	15
296	130	230	200	356	8 x 18	110	219	—	450	15
282	130	230	200	342	8 x 18	90	205	300	—	15
282	130	230	200	342	8 x 18	90	205	—	450	15
268	130	230	200	328	8 x 18	70	191	300	—	15
268	130	230	200	328	8 x 18	70	191	—	450	15

l1 kurze Ausführung l2 lange Ausführung

Federsteifigkeiten			max. Belastungen			Masse Stück [kg]	Elastomer Härte [Shore A]	Form-Nr.	Artikel-Nr.
C _x [N/mm]	C _y [N/mm]	C _z [N/mm]	F _x [N]	F _y [N]	F _z [N]				
640	3616	3616	6700	20000	20000	20,99	55	21055	■
960	5423	5423	10050	30000	30000	25,92	55	21055	■
480	2931	2931	3400	7500	7500	7,21	55	25079	■
720	4397	4397	5100	11250	11250	9,18	55	25079	■
437	1796	1796	6640	17000	17000	21,73	55	58394	■
437	1796	1796	6640	17000	17000	27,02	55	58394	■
768	9303	9303	6758	22000	22000	20,25	55	21055a	■
1152	13954	13954	10137	33000	33000	24,81	55	21055a	■
183	758	758	3000	7500	7500	7,70	55	24472c	■
275	1137	1137	4500	11250	11250	9,92	55	24472c	■
275	1191	1191	3400	7500	7500	7,46	55	24472d	■
413	1786	1786	5100	11250	11250	9,55	55	24472d	■
735	2917	2917	12100	30000	30000	41,40	55	38417a	■
1103	4376	4376	12100	30000	30000	51,80	55	38417a	■
981	4905	4905	12194	30000	30000	40,10	55	38417b	■
1472	7358	7358	18291	45000	45000	49,80	55	38417b	■
1468	11190	11190	11965	32500	32500	38,70	55	38417c	■
2202	16785	16785	17948	48750	48750	47,80	55	38417c	■

■ Anfertigungsware

Belastungsrichtungen

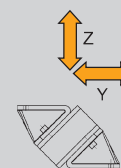

SCHWINGMETALL® Schräglager

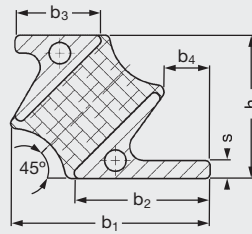

Schrägschienen

Abmessungen

b ₁ [mm]	b ₂ [mm]	b ₃ [mm]	b ₄ [mm]	h [mm]	Länge [mm]	s [mm]
108	76	48	28	80	75	10
108	76	48	28	80	200	10
144	105	67	38	106	75	15
144	105	67	38	106	200	15

- SCHWINGMETALL®-Schrägschienen werden als Standardausführung mit einem Elastomer-Werkstoff auf Basis von Chloropren-Kautschuk geliefert.

Federsteifigkeiten			max. Belastungen			Masse Stück [kg]	Elastomer		Form-Nr.	Artikel-Nr.
C _x [N/mm]	C _y [N/mm]	C _z [N/mm]	F _x [N]	F _y [N]	F _z [N]		Typ	Härte [Shore A]		
215	86	215	2500	860	2500	1,56	CR	55	38537	■
895	307	895	600	3070	600	4,31	CR	55	38538	3978702000
320	103	320	3000	1200	3000	2,87	CR	55	38539	■
1200	315	1200	9000	3500	9000	8,05	CR	55	38540	3978704000

■ Anfertigungsware

Belastungsrichtungen

